

Adelphi Tubes

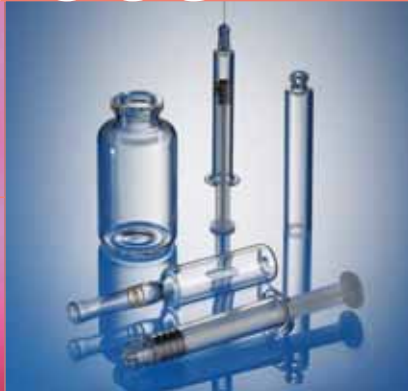

Adelphi Tubes
Healthcare Packaging



Healthcare Packaging

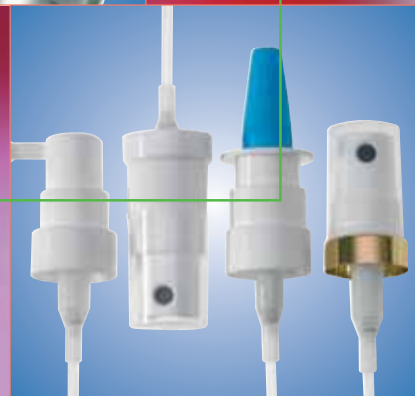

Introduction and Contents

Adelphi Tubes was established in 1970 and specialises in the supply of primary packaging components to the healthcare industry. One of the reasons for our continued success is the strength of the partnerships we have formed with a number of the world's leading manufacturers. As exclusive representatives, we invariably act as the catalyst between the customer and the manufacturer to ensure that the quality of the product is only rivalled by the quality of our service. Please see pages 2 to 6 for profiles on our partners.

Our aim is to provide a highly competent, creative and customer-focused service whatever the size and specific nature of our customers' requirements.

Our partners

Page 2-3 SCHOTT forma vitrum profile



Page 4 West Pharmaceutical Services profile



Page 5 Linhardt profile



Page 5-6 Aero Pump profile



Page 6 Medisize profile



Stock products

- Page 7 Injection/Freeze drying vials, Infusion bottles and Sterile Nitrogen filled vials
- Page 8 Rubber stoppers and Aluminium seals
- Page 9 Diagnostic vials, Closure systems and Dropper packs
- Page 10 Ampoules and Ampoule boxes
- Page 11 Kylix glass bottles, Liquida PET bottles and Closures
- Page 12 Aluminium tubes, Pharma PE dropper bottles, SCHOTT Duran laboratory bottles
- Page 13 Vial boxes and All Purpose Dispensing (APD) boxes
- Page 14 Custom products

Dimensions given in this brochure are in millimetres and are for guidance only, not constituting a product specification. Container brimful capacities are approximate. Assessing suitability of the products detailed herein is incumbent on the user.

SCHOTT is the market leader in speciality glass products

SCHOTT forma vitrum focuses on the development and manufacturing of primary packaging products made of specialised glass and polymers for the pharmaceutical industry. With production sites worldwide and an output in excess of 6 billion components per year, SCHOTT forma vitrum can meet its customers' requirements wherever they are located.

With Adelphi acting as the European distribution operation for SCHOTT forma vitrum, we have the possibility to meet your demand however large or small.



■ SCHOTT forma vitrum products

SCHOTT forma vitrum products include:

- forma 3s® pre-fill sterile syringes in glass
- TopPac® pre-fill sterile syringes in COC polymer
- Glass vials 1ml to 120ml, injection neck, screw neck
- Ampoules 0.5ml to 50ml, open, closed, OPC, breaking
- Cartridges - pen system, needle free injectors, dental
- Dropper pipettes and assemblies
- Culture tubes
- Plastic closures



■ SCHOTT Purgard®

Purgard® aerosol bottles - inert inner Type I glass container with outer protective injection moulded polymer jacket. A clear example of SCHOTT competencies combined in one unique product.



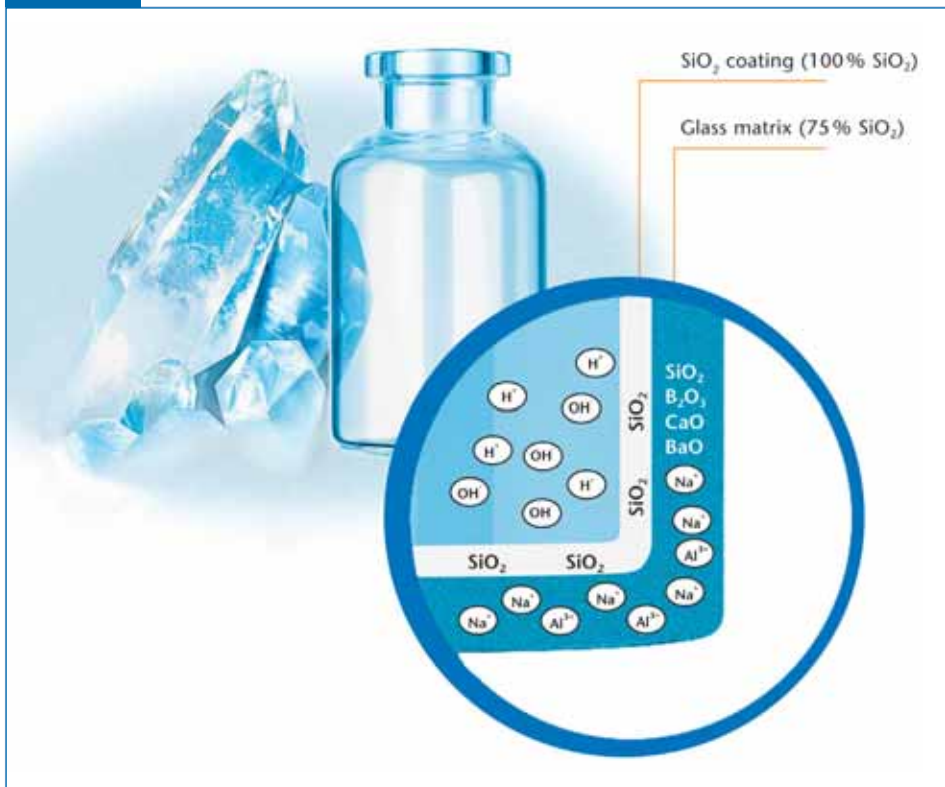

SCHOTT Type I plus®

Containers have surface properties like quartz: purity and inertness. The container can be washed, depyrogenated, filled, closed, inspected and sterilized just like standard containers. It is particularly suitable for products where conventional containers made of pharmaceutical Type I glass have reached their limits, such as with:

■ SCHOTT Type I plus® vials available in sizes from 2ml to 100ml

- Low concentrated proteins with adsorption tendencies
- High pH products
- Preparations which cannot tolerate a pH shift or ion leaching
- Formulations that react with metal ions
- Preparations with degradation tendencies
- Formulations containing complexing agents e.g. citrates, EDTA
- Radioactive diagnostics

The SCHOTT forma vitrum product lines

Excellent quality from standard level up to tailor-made solutions for the highest requirements. Vials and cartridges are available in three quality options.

TopLine	Tailor-made solutions for specific requirements. TopLine products are individually designed to meet advanced technical requirements according to customer specifications, enabling you to stay one step ahead.
ClearLine	Advanced product solutions for superior demands. SCHOTT forma vitrum exclusive forming technology and 100% dimensional and cosmetic inspection ensure an excellent production performance on your filling lines.
StandardLine	High quality products complying with international standards. The SCHOTT forma vitrum StandardLine is the well established high-level quality complying with international standards.



■ SCHOTT TopLine quality vials

West Pharmaceutical Services



West Pharmaceutical Services is the world's premier manufacturer of elastomer components and systems for injectable drug delivery, including stoppers and seals for vials, closures and disposable components used in syringes, IV and blood collection systems.

West applies more than 80 years of experience to developing, manufacturing and selling components and systems used for injectable drug delivery.

West products include:

- Injection and lyophilization stoppers
- Plungers
- Components for intravenous systems
- Aluminium seals

Adelphi offer West FluroTec® stoppers from stock

Injection and lyophilization stoppers with fluorocarbon protective film barrier. By choosing FluroTec® stoppers you can:

- Improve the shelf life of your packaged drugs
- Reduce the occurrence of visible and subvisible particles
- Improve the compatibility of the closure and the drug
 - Reduced interaction of extractables from the rubber
 - Reduced accumulation of leachables in the drug formulation



■ FluroTec® stoppers and syringe plungers

West Flip-Off® CCS seals. Clean - Certified - Sterile

Addresses the needs of pharmaceutical manufacturers for secondary closures in aseptic filling operations. CCS seals are certified with regard to bioburden and cleanliness and are designed to be used in a sterile manufacturing environment.



■ West aluminium seals

Established for more than 60 years, Linhardt is a leading manufacturer of collapsible tubes and rigid aluminium containers.

With three factories in Germany specialising in the production of aluminium tubes for the pharmaceutical industry and high quality plastic tubes for the cosmetics & toiletries markets, Linhardt provides a collective large scale operation with local flexibility and customer orientation.

The clean factory at the Viechtach facility provides the highest industry standard in controlled environment packing and cGMP.



■ Collapsible aluminium tubes



■ Rigid aluminium containers



■ Collapsible plastic tubes

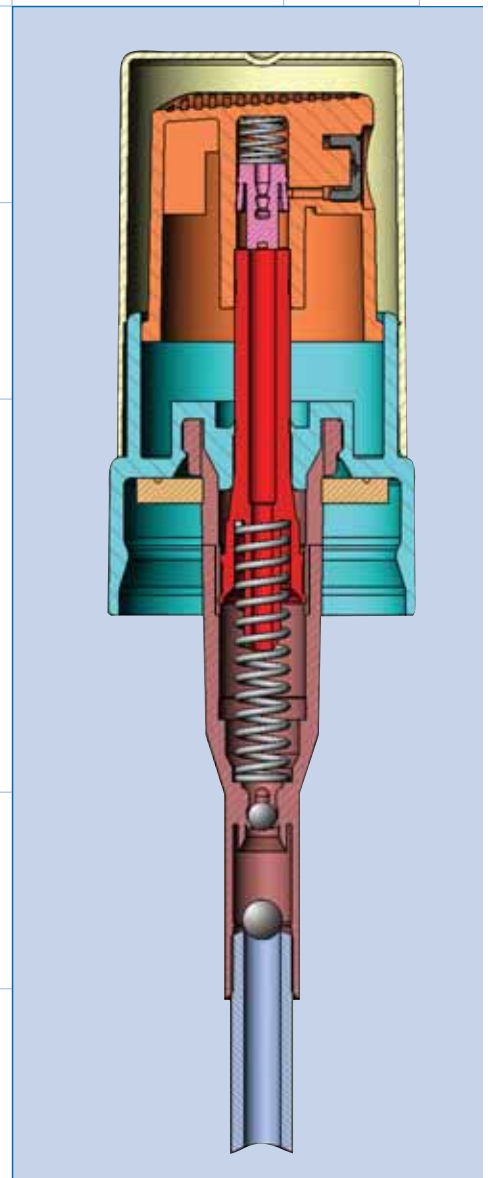



Medisize Schweiz is specialised in the development and manufacturing of complete packaging solutions, dispensing systems and plastic devices for the pharmaceutical, healthcare and medical industries.

Located near to Zurich, Medisize Schweiz formerly Createchnic has a worldwide reputation as a highly innovative and competent company in the field of pharmaceutical plastics packaging.

- Bottles for ophthalmics and other applications, 5ml to 50ml cleanroom manufactured and packed. Can be supplied sterile.

Medisize's comprehensive know-how enables them to invent and develop in a broad range of activities.

- Complex plastic components with assembly of multiple parts for medical devices
- Containers/bottles and closures for the pharmaceutical, medical and body care industries
- Hinged closures
- Tamper evident and child resistant closure systems
- Dispensing systems



Aero Pump is a specialist producer of atomisers and dispensing pumps for the pharmaceutical and cosmetic industries. Located near to Frankfurt Germany, Aero Pump manufacture in a state of the art purpose built factory. The products are processed under ISO Class 7 cleanroom conditions.



- Pumps for snap on, screw and crimp neck bottles

Aero Pump's modular system affords pumps with different kinds of closures and dosages for applications including nasal and throat sprays. The use of high-quality and approved raw materials in combination with a flexible assembly technology always guarantees a constant quality.



- Customised components and dispensing systems, medical devices.



- Injection blow moulded pump spray bottles with snap on, screw and crimp neck, 10ml to 100ml cleanroom manufactured and packed.

Vials & Infusion bottles

Tubular glass vials are manufactured by SCHOTT forma vitrum from SCHOTT Fiolax® neutral Type I glass tubing. Vials can be manufactured to your precise specification for viable production runs.

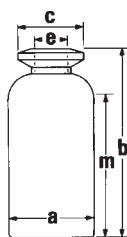

A Tubular Type I glass injection/freeze drying vials



■ Tubular Type I glass injection/freeze drying vials

Clear Vials	Size	Brimful	a	b	t	c	e	m
VC002-13C	2ml	3.8ml	14.25	39.5	0.95	13	7.0	26
VCDIN2R	2ml	4ml	16.0	35.0	1.0	13	7.0	22
VC005-20C	5ml	9.7ml	22.25	38.0	1.1	20	12.75	24.5
VCDIN6R	5ml	10ml	22.0	40.0	1.0	20	12.6	27
VC010-20C	10ml	14ml	24.25	46.0	1.1	20	12.75	32
VCDIN10R	10ml	13.5ml	24.0	45.0	1.0	20	12.6	31
VC020-20C	20ml	26.5ml	29.25	56.0	1.1	20	12.75	38
VCDIN30R	30ml	37.5ml	30.0	75.0	1.2	20	12.6	55
VCT050-20C	50ml	65ml	42.5	68.0	1.5	20	12.6	42

Amber Vials	Size	Brimful	a	b	t	c	e	m
VADIN2R	2ml	4ml	16.0	35.0	1.0	13	7.0	22
VADIN6R	6ml	10ml	22.0	40.0	1.0	20	12.6	27
VADIN10R	10ml	13.5ml	24.0	45.0	1.0	20	12.6	31

'DIN' vials conforming to ISO 8362-1
Other sizes subject to availability

B Moulded Type I glass injection/freeze drying vials, ISO 8362-4



■ Moulded Type I glass injection/freeze drying vials

	Size	Brimful	a	b	c	e	m
V*010-20C	10ml	15ml	25.4	53.5	20	12.6	35.3
V*020-20C	20ml	26ml	32.0	58.0	20	12.6	36.1
V*030-20C	30ml	38ml	36.0	62.8	20	12.6	41.3
V*050-20C	50ml	60ml	42.5	73.0	20	12.6	46.0
V*100-20C	100ml	119ml	51.6	94.5	20	12.6	58.0
VC200-20C	200ml	246ml	65.0	114.5	20	12.6	76.0

* Available in Clear C or Amber A glass

C Infusion bottles

Manufactured according to ISO 8536 and DIN 58363 with 32mm crimp neck and packed in shrink-wrapped hygiene bricks.

Available in both Type I and Type II glass, clear and amber, plain and graduated. Sizes from 50ml to 1000ml.

Availability depends on specification and required quantity.



■ Infusion bottles

D Sterile Nitrogen filled vials

Ready to fill vials, internally apyrogenic and sterile with a Nitrogen atmosphere. Stock size 10ml, sizes from 2ml to 50ml produced to order. CE marked and conforming to ISO13485.



■ Sterile Nitrogen filled vials

Rubber stoppers/Aluminium seals

Adelphi Tubes stock products manufactured by West Pharmaceutical Services.

Rubber stoppers

- A** INJW13RtS 13mm injection, bromobutyl
- B** INJW20RtS 20mm injection, bromobutyl
- C** INJW20S 20mm Silicone
- D** INJ20WC 20mm injection, chlorobutyl
- E** FDW13 13mm lyophilization, igloo, bromobutyl
- F** FDW20RtS 20mm lyophilization, igloo, bromobutyl
- G** FDIA20/1612 20mm lyophilization, cruciform, bromobutyl
- H** INJW32G2RtS 32mm infusion, bromobutyl

FluroTec® rubber stoppers

- A** INJ13TBWRS 13mm injection, Flurotec, B2-40, Westar RS
- B** INJ20TBWRS 20mm injection, Flurotec, B2-40, Westar RS
- C** FD13TBRtS 13mm lyophilization, Flurotec, B2-40, Ready to Sterilize
- D** FD20TBRtS 20mm lyophilization, Flurotec, B2-40, Ready to Sterilize
- E** INJ13TB3WRS 13mm injection, Flurotec, B2-40, Westar RS
- F** INJ20TB3WRS 20mm injection, Flurotec, B2-40, Westar RS
- G** FD13TT3WRS 13mm lyophilization, Flurotec, B2-40, Ready to Sterilize
- H** FD20TT3WRS 20mm lyophilization, Flurotec, B2-40, Ready to Sterilize

Ready to Sterilize (RtS) and Westar RS (WRS): final rinse in WFI and packed in Class 100 clean room into a STERILIZABLEBAG™.

B2-40: Cross-linked silicone coating applied to the top surface of the rubber stopper.

Aluminium seals

Various aluminium and plastic colours available.

- A** CEHW13 13mm centre hole
- B** CEHW20 20mm centre hole
- C** CETW13 13mm centre tear off
- D** CETW20 20mm centre tear off
- E** COTW13 13mm complete tear off
- F** COTW20 20mm complete tear off
- G** FOT13 13mm Flip Off
- H** FOT20 20mm Flip Off
- I** FT13 13mm Flip Top
- J** FT20 20mm Flip Top
- K** FTU13 13mm Flip Tear Up
- L** FTU20 20mm Flip Tear Up
- M** FOTO20 20mm Flip Off Tear Off
- N** COT20HT 20mm complete tear off
- O** FTR32 32mm FTR



■ Standard rubber injection and lyophilization stoppers

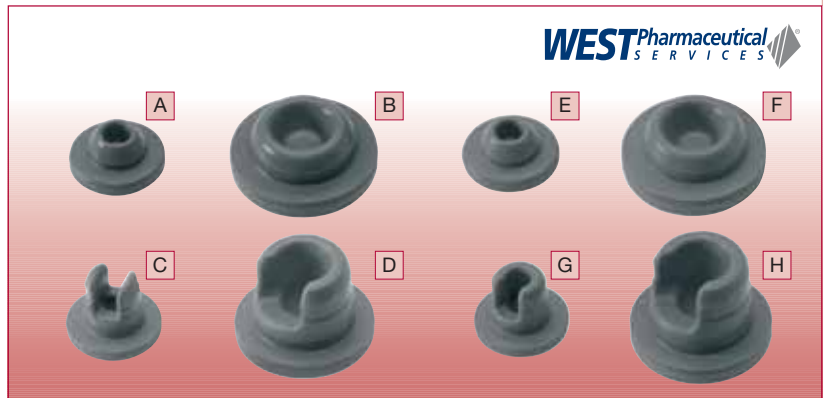

■ FluroTec® stoppers



■ Aluminium seals

Diagnostic vials, Closure systems & Dropper packs

Clear and amber Type I neutral glass vials manufactured by SCHOTT forma vitrum from SCHOTT Fiolax® tubing. Vials can be manufactured to your precise specifications for viable production runs.

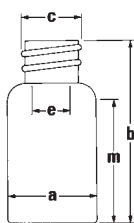

A Tubular Type I glass diagnostic vials

C-Clear glass A-Amber glass

Ref	C/A	Size	Brimful	a	b	t	c	e	m
VCD003	C	3ml	5.8ml	18.0	36.0	1.0	14	8.6	22.3
VAD003	A	3ml	5.8ml	18.0	36.0	1.0	14	8.6	22.3
VCD005	C	5ml	6.7ml	18.0	41.5	1.0	14	8.6	27.7
VAD005	A	5ml	6.7ml	18.0	41.5	1.0	14	8.6	27.7
F-3059	C	6ml	9.5ml	22.0	40.0	1.0	18	11.5	23.7
VCD010	C	10ml	13.5ml	23.75	48.0	1.1	18	11.5	30.6
VADDIN010	A	10ml	12.5ml	24.0	45.0	1.2	18	11.5	29.0

B Rubber stoppers

- A SDIA14 14mm DIN plug, chlorobutyl
- B FDIA14WG/B 14mm DIN lyophilization, bromobutyl
- C SDIA18RtS 18mm DIN plug, chlorobutyl
- D FDIA18W/B 18mm DIN lyophilization, chlorobutyl/bromobutyl
- E FDIA22 22mm DIN lyophilization, chlorobutyl
- F SDIA22 22mm DIN plug, chlorobutyl

C Screw caps

- A GL14 smooth Unwadded, plug seal
- B GL14 8 ribbed Unwadded, plug seal, EPE wadded, PTFE wadded
- C GL18 Unwadded, plug seal, EPE wadded, PTFE wadded
- D GL22 Unwadded, plug seal, EPE wadded, PTFE wadded

Material: Polypropylene, High Density Polyethylene, Pvcan (PBT high heat resistance), PvdF.

Colours: Many colours such as red, blue, yellow, green and black are stocked. Please check availability.

D Dropper packs

SCHOTT forma vitrum screw neck vials and dropper assemblies.

We can supply droppers with:

- Siliconised pipettes, Type I & III glass and plastic
- Tamper evident caps
- Customised drop size
- Variety of tip designs
- Sterile or ready to sterilize



■ Diagnostic vials



■ Diagnostic stoppers

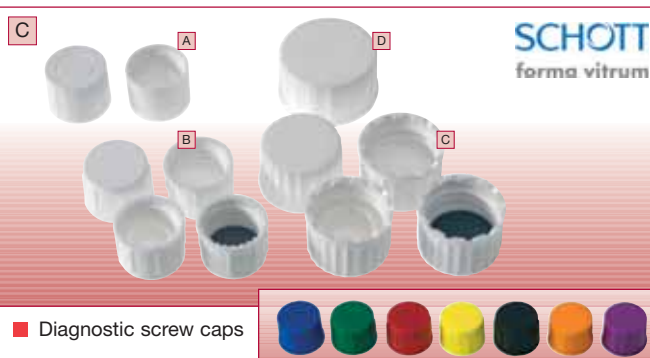

■ Diagnostic screw caps



■ Screw neck vials and dropper assemblies

Ampoules/Ampoule boxes

Open and closed ampoules manufactured by SCHOTT forma vitrum according to ISO 9187-1:2000. Manufactured from SCHOTT Fiolax® Neutral Type I glass, with Colourbreak or OPC (One Point Cut) for easy opening. Ampoules can be printed and manufactured to your precise specification for viable production runs.

One Point Cut (OPC) benefits over Colourbreak opening system: Tighter limits for breakforce and more consistent results for easier and safer opening. Cleaner break aspect with no risk of enamel particles contaminating the product.



A Open ampoules

*C-Clear glass *A-Amber glass

Ref	Size	*	a	b	d	e	n
AIO*001	1ml	C/A	10.75	21.0	60.0	8.0	25.5
AIO*002	2ml	C/A	10.75	33.0	72.0	8.0	37.5
AIO*005	5ml	C/A	14.75	41.0	83.0	9.0	46.5
AIO*010	10ml	C/A	17.75	55.0	102.0	9.5	62.0
AIOC020	20ml	C	22.50	65.0	113.0	11.0	76.0
AOC050	50ml	C	27.50	107.0	170.0	12.0	116.5

Closed ampoules

*A-Amber glass, white Colourbreak *C-Clear glass, white Colourbreak
*AF-Amber glass, OPC white dot *CF-Clear glass, OPC red dot

Ref	Size	*	a	b	d	e	n
AIC*001	1ml	C/AF/CF	10.75	21.0	70.0	6.0	25.5
AIC*002	2ml	C/AF/CF	10.75	33.0	83.0	6.0	37.5
AIC*005	5ml	A/C/AF/CF	14.75	41.0	95.0	7.0	46.5
AIC*010	10ml	A/C/CF	17.75	55.0	112.0	7.1	62.0
AICC020	20ml	C	22.50	65.0	126.0	7.8	76.0
AICC025	25ml	C	27.50	107.0	141.0	7.8	116.5

One Point Cut (OPC)

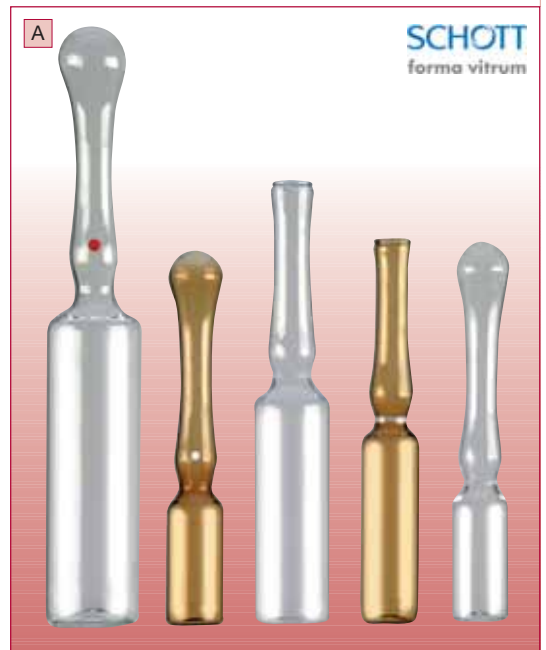
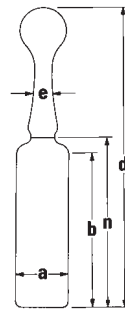
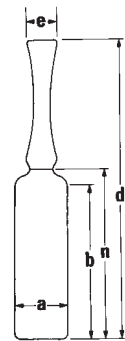

Open and closed ampoules

B Ampoule boxes

Ref	Size	Ref	Size
BO001	5x1ml	BO005	10x1ml
BO002	5x2ml	BO006	10x2ml
BO003	5x5ml	BO007	10x5ml
BO004	5x10ml	BO009	10x10ml
		BO008A	10x20ml

Every ampoule is firmly gripped in a vacuum formed plastic fitment. The one piece design ensures that lids bearing instructions do not become parted from their contents.

B



Ampoule boxes

Kylix glass and Liquida PET bottles

A Kylix bottles

Type III clear and amber glass bottles from stock, all with PP28 neck finish. The Kylix bottles are produced by press-and-blow moulding technology, affording a lighter, yet stronger bottle due to improved glass distribution. Kylix bottles are supplied in hygienic shrink-wrapped packs with certification.

ref	ml	ml	g		mm	mm
K*0030	30	37	39	PP28	67.0	35.0
K*0060	60	67.5	53	PP28	94.0	38.6
K*0090	90	97.5	69	PP28	103.0	43.9
K*0100	100	108	70	PP28	104.8	46.1
K*0125	125	133.5	79	PP28	114.4	49.0
K*0150	150	158	100	PP28	122.8	51.6
K*0200	200	209	115	PP28	133.3	57.0
K*0250	250	260	146	PP28	142.9	61.7
K*0300	300	315	170	PP28	151.3	65.6
KC0500	500	512	305	PP28	190.0	76.0
KA0500	500	528	240	PP28	176.8	76.8
K*1000	1000	1021	470	PP28	217.0	97.5

* Available in Clear C or Amber A glass

C Liquida PET bottles

Injection stretch blow moulded PET containers with PP28 thread and special drip-free pouring neck. Manufactured from amber transparent or clear PET by Medisize Schweiz. Subject to availability and viable minimum order quantity.

ref	ml	ml		mm	mm
35107	50	66	PP28	87.3	38.0
35168	100	115	PP28	116.0	40.0
35108	125	135	PP28	113.0	46.1
35109	150	158	PP28	119.0	49.3
35110	200	210	PP28	119.0	57.0
35115	250	262	PP28	139.0	58.5
35113	300	322	PP28	155.0	60.5
35112	500	525	PP28	182.5	70.8

A



■ Kylix bottles

B Closures

- A 6-4418 Tamper evident, child resistant, EPE wadded
- B 5-4418 Tamper evident, EPE wadded
- 5-4416 Tamper evident, wadless
- C HTEC28TWWB Tamper evident, PTFE wadded
- D PP28 * Tamper evident, PE plug seal
- E IL13W Polypropylene, EPE wadded
- F PS356 Aluminium, wadless
- G SW27 Silicone wad
- H INJ28V * Chlorobutyl rubber stopper

* Not suitable for Liquida PET bottles

B

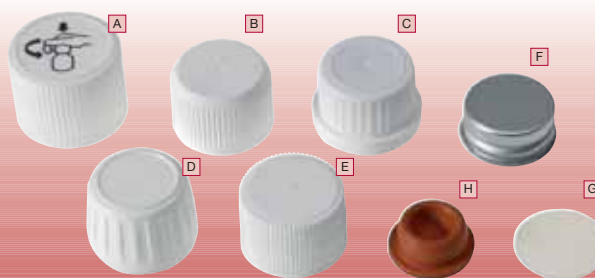

■ Closures

C



creating smarter solutions
MEDISIZE

■ Liquida PET bottles

Aluminium tubes/Dropper bottles/ SCHOTT Duran laboratory bottles

A Aluminium tubes

Internally lacquered, white enamelled aluminium collapsible tubes manufactured by Linhardt. We can also supply the tubes printed, with a variety of closure, nozzle options and latex end seal subject to minimum viable production quantities. Plastic tubes are also available.

Ref	Capacity	Size (mm)	Orifice size (mm)	Nozzle	Style of cap
TL001	5ml	13.5x55	1.5 ¹	-	A
TL002	15ml	16x101	3.5	M7	B
TL003A	20ml	19x101	5.5	M9	B
TL004	28ml	22x101	5.5	M9	B
TL005A	56ml	25x140	5.5	M9	B
TL007	112ml	35x160	7.0 ²	M11	B

¹ Eye ointment tube with plastic elongated nozzle

² Membrane nozzle

Cap style: A = Elongated White HDPE

B = Short Screw HDPE Flowerpot

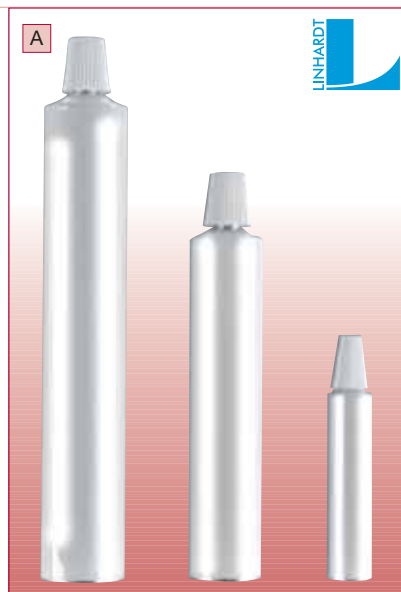

■ Aluminium tubes

B Pharma dropper bottle systems

Manufactured by Medisize Schweiz under cleanroom conditions and sealed into poly bags in the cleanroom. All components can be supplied sterile subject to viable minimum order quantity.

ref	ml	ml	mm	mm		mm
35017	5ml	8.45	21.0	44.0	14x2.5	57.8
35018	10ml	12.1	24.0	50.0	14x2.5	63.4
35020	15ml	18.2	25.0	62.0	14x2.5	75.4
35072	20ml	24.0	28.0	63.5	14x2.5	77.4
35021	30ml	34.5	30.0	76.5	14x2.5	89.6
35071	55ml	59.0	35.0	89.5	14x2.5	104.0
92200	Tamper evident white cap					
92236	Dropper nozzle, 0.03ml (0.05ml nozzle also available)					

Coloured bottles and caps produced to order subject to viable minimum order quantity.



■ Pharma PE dropper bottles

C SCHOTT Duran laboratory bottles

DIN thread ISO 4796

ml	Neck	C	CF	A	CI
25	GL25	21 801 14(2)	21 801 142(2)	21 806 14(2)	-
50	GL32	21 801 17	21 801 175	21 806 17	-
100	GL45	21 801 24(1,4)	21 801 245(1)	21 806 24(1)	21 805 24(1)
250	GL45	21 801 36(1,4)	21 801 365(1)	21 806 36(1)	21 805 36(1)
500	GL45	21 801 44(1,4)	21 801 445(1)	21 806 44(1)	21 805 44(1)
1000	GL45	21 801 54(1,3,4)	21 801 545(1)	21 806 54(1,3)	21 805 54(1)
2000	GL45	21 801 63(1)	21 801 635(1)	21 806 63(1)	21 805 63(1)
5000	GL45	21 801 73	21 801 735	21 806 73	21 805 73
10000	GL45	21 801 86	21 801 865	21 806 86	-
15000	GL45	21 801 88	21 801 885	21 806 88	-
20000	GL45	21 801 91	21 801 915	21 806 91	-

C Clear, graduated without cap and pouring ring

CF Clear, graduated fitted with blue PP cap and pouring ring

A Amber, graduated without cap and pouring ring

CI Clear, graduated Levasint® coated without cap and pouring ring

1 Bead moulded into bottle's shoulder to indicate nominal capacity level

2 Specially formed lip on neck for better pouring, additional plastic pouring ring unnecessary

3 Available as pressure or vacuum resistant

4 Available as square bottles



■ Duran bottles

Boxes

A All Purpose Dispensing (APD) boxes

Versatile range of round lidded boxes which can be supplied to order with coloured and printed outer covering for viable production quantities.

Ref	Size (ml)	Description	Internal diameter	External height
ACDH	14	½oz cut-down	35mm	21mm
ADH	20	½oz deep	35mm	27mm
ACD1	26	1oz cut-down	41mm	27mm
AD1	40	1oz deep	41mm	37mm
ACD2	54	2oz cut-down	51mm	31mm
AD2	77	2oz deep	51mm	45mm
AD4	162	4oz deep	62mm	57mm

A



■ All Purpose Dispensing (APD) boxes

B Vial boxes

With a minimum quantity of only 100 units, we can produce an elegant, yet low cost box to suit your particular requirements. The options include:

- Hinged or loose lid
- Card fitments
- A wide variety of coloured or textured coverings

B



Custom products

In addition to the standard ranges detailed on the previous pages we also supply a wide variety of container and closure systems according to the specific needs of our customers.

An example of some of the packaging components we are supplying to our customers.



We offer a one-stop-shop supply solution for our customers whose businesses depend on Adelpi maintaining supplies of a diverse selection of components for supply often the next day. We have a highly sophisticated logistics operation giving you the peace of mind to completely trust your packaging supply chain to us.

Other companies in the Adelphi Group include:

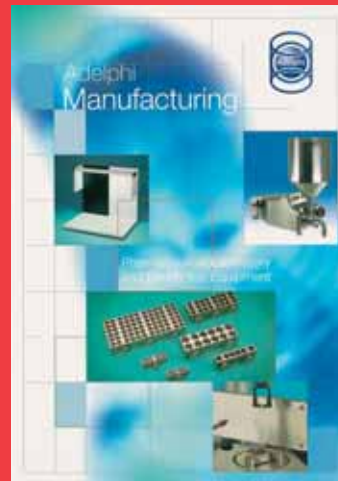
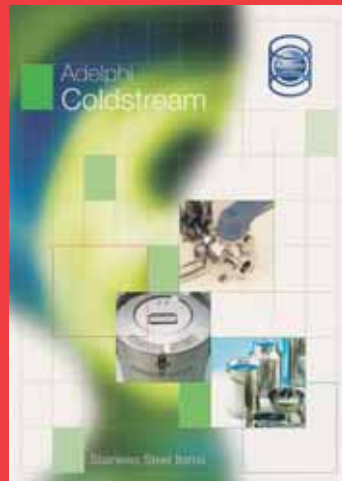

ISO 9001:2000
FM 24070



ISO 13485:2003
MD 84804

Adelphi Tubes

Olympus House, Mill Green Road, Haywards Heath, West Sussex RH16 1XQ. UK

T: +44 (0)1444 472300 F: +44 (0)1444 472329 E: sales@adelphi.uk.com www.adelphi.uk.com

Part of the Adelphi Group of Companies